

AF- The product code of all endoscopic flexible instruments

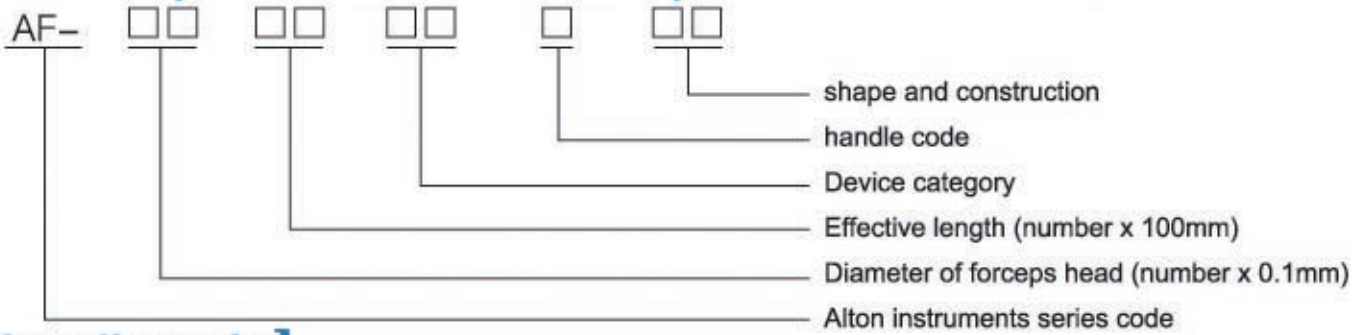

[handle code]

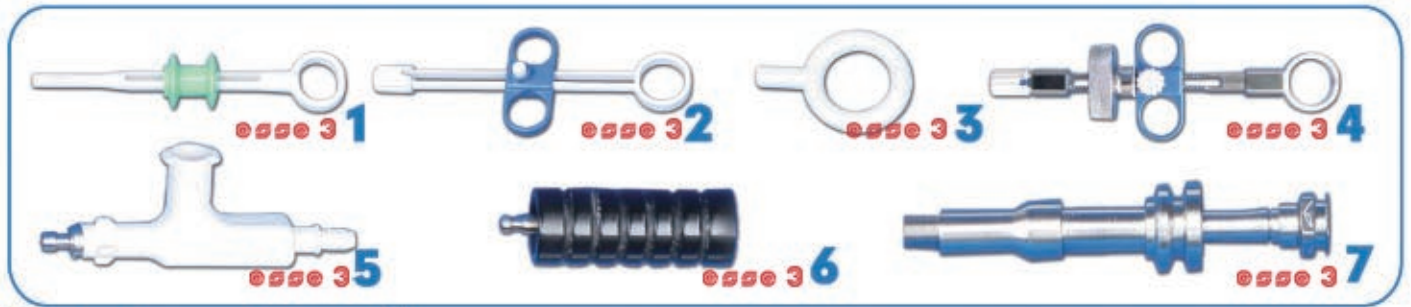

[Device category]



| | Biopsy Forceps (Autoclave) | | Grasping Forceps | |
|--------------|---|--------------|-----------------------------------|----------------|
| BS | Standard biopsy forceps | DT4 | Stomach stones cutter | |
| BT | Oval fenestrated cups | GH | Alligator jaws type | |
| BU | Alligator cups | GI | Rat tooth type | |
| BV | Alligator single moving cups | GJ | Rat tooth with alligator | |
| BW | Oval fenestrated cups with spike | GK | Pelican jaws type | |
| BWU | Alligator cups with spike | GL | Basket type | |
| | Accessories for HF Current Devices (Autoclave) | GM102 | Rubber tips type | |
| | | GM103 | 3- Prong type | |
| | | GM105 | 5- Prong type | |
| DT | Standard oval type snare | | Washing Pipe (Autoclave) | |
| DL | Herangular type snare | | | |
| DB | Half-moon type snare | | | |
| DZ | Easting knife in the shape of metal | PA | Standard type | |
| DJ | Poasting knife line of metal | PB | Spray type | |
| DG | Hot biopsy forceps | PN | Injection needle | |
| DQ | Ball type coagulation electrodes | | Brushes | |
| | Scissors Type (Autoclave) | WA301 | | Cleaning brush |
| GO101 | Surgical scissos | WA302 | | Cytology brush |
| GO102 | N-scissos | WA303 | Brush for aqueous button cleaning | |

[Colour Description]

used for Gastroscope
 used for Coloscope
 used for Bronchoscope
 used for Enteroscope
 used for Choledochoscope

Biopsy Forceps (Autoclave)

■ Gastroscope
 ■ Coloscope
 ■ Bronchoscope
 ■ Enteroscope
 ■ Choledochoscope



| Type | Model | Spec | Type | Model | Spec |
|--|------------|---------------|--|------------|---------------|
|  <p>Standard biopsy forceps</p> | AF-1815BS1 | Ø1.8 x 1500mm |  <p>Alligator cups</p> | AF-1815BU1 | Ø1.8 x 1500mm |
| | AF-2415BS1 | Ø2.4 x 1500mm | | AF-2415BU1 | Ø2.4 x 1500mm |
| | AF-2417BS1 | Ø2.4 x 1700mm | | AF-2417BU1 | Ø2.4 x 1700mm |
| | AF-2421BS1 | Ø2.4 x 2100mm | | AF-2421BU1 | Ø2.4 x 2100mm |
| | AF-2423BS1 | Ø2.4 x 2300mm | | AF-2423BU1 | Ø2.4 x 2300mm |
| | AF-1810BS1 | Ø1.8 x 1000mm | | AF-1810BU1 | Ø1.8 x 1000mm |
| | AF-1825BS1 | Ø1.8 x 2500mm | | AF-1807BU1 | Ø1.8 x 700mm |

| | | | | | |
|--|---------------|---------------|---|-------------|---------------|
|  <p>Oval fenestrated cups</p> | AF-1815BT1 | Ø1.8 x 1500mm |  <p>Alligator cups with spike</p> | AF-2415BWU1 | Ø2.4 x 1500mm |
| | AF-2415BT1 | Ø2.4 x 1500mm | | AF-2417BWU1 | Ø2.4 x 1700mm |
| | AF-2417BT1 | Ø2.4 x 1700mm | | AF-2421BWU1 | Ø2.4 x 2100mm |
| | AF-2215BT1 | Ø2.2 x 1500mm | | AF-2423BWU1 | Ø2.4 x 2300mm |
| | AF-2421BT1 | Ø2.4 x 2100mm | | | |
| | AF-2423BT1 | Ø2.4 x 2300mm | | | |
| | AF-2221BT1 | Ø2.2 x 2100mm | | | |
| | AF-1810BT1 | Ø1.8 x 1000mm | | | |
| AF-1825BT1 | Ø1.8 x 2500mm | | | | |

| | | | | | |
|--|---------------|---------------|---|------------|---------------|
|  <p>Oval fenestrated cups with spike</p> | AF-1815BW1 | Ø1.8 x 1500mm |  <p>Alligator single moving cups</p> | AF-1815BV1 | Ø1.8 x 1500mm |
| | AF-2415BW1 | Ø2.4 x 1500mm | | AF-2415BV1 | Ø2.4 x 1500mm |
| | AF-2417BW1 | Ø2.4 x 1700mm | | AF-2417BV1 | Ø2.4 x 1700mm |
| | AF-2215BW1 | Ø2.2 x 1500mm | | AF-2421BV1 | Ø2.4 x 2100mm |
| | AF-2421BW1 | Ø2.4 x 2100mm | | AF-2423BV1 | Ø2.4 x 2300mm |
| | AF-2423BW1 | Ø2.4 x 2300mm | | AF-1810BV1 | Ø1.8 x 1000mm |
| | AF-2221BW1 | Ø2.2 x 2100mm | | AF-1807BV1 | Ø1.8 x 700mm |
| | AF-1810BW1 | Ø1.8 x 1000mm | | | |
| AF-1825BW1 | Ø1.8 x 2500mm | | | | |

Grasping Forceps (Autoclave)



■ Gastroscope
 ■ Coloscope
 ■ Bronchoscope
 ■ Enteroscope
 ■ Choledochoscope



| | | | | | |
|--|------------|---------------|---|------------|---------------|
|  <p>Mental injection needle</p> | AF-1816PN7 | Ø1.8 x 1600mm |  <p>Standard type</p> | AF-1816PA5 | Ø1.8 x 1600mm |
| | AF-2416PN7 | Ø2.4 x 1600mm | | AF-2416PA5 | Ø2.4 x 1600mm |
| | AF-2422PN7 | Ø2.4 x 2200mm | | AF-2422PA5 | Ø2.4 x 2200mm |
| | AF-1810PN7 | Ø1.8 x 1000mm | | AF-1810PA5 | Ø1.8 x 1000mm |
| | AF-1825PN7 | Ø1.8 x 2500mm | | | |



| | | | | | |
|--|------------|---------------|--|------------|---------------|
|  <p>Teflon injection needle</p> | AF-1816PN7 | Ø1.8 x 1600mm |  <p>Spray type</p> | AF-1816PB5 | Ø1.8 x 1600mm |
| | AF-2416PN7 | Ø2.4 x 1600mm | | AF-2416PB5 | Ø2.4 x 1600mm |
| | AF-2422PN7 | Ø2.4 x 2200mm | | AF-2422PB5 | Ø2.4 x 2200mm |
| | AF-1810PN7 | Ø1.8 x 1000mm | | | |
| | AF-1825PN7 | Ø1.8 x 2500mm | | | |

Grasping Forceps (Autoclave)

■ Gastroscope
 ■ Colonoscope
 ■ Bronchoscope
 ■ Enteroscope
 ■ Choledochoscope

| Type | Model | Spec | Type | Model | Spec |
|---|--------------|---------------|--|--------------|---------------|
|  <p>3-prong type</p> | AF-1815GM103 | Ø1.8 x 1500mm |  <p>5-prong type</p> | AF-1815GM105 | Ø1.8 x 1500mm |
| | AF-2415GM103 | Ø2.4 x 1500mm | | AF-2415GM105 | Ø2.4 x 1500mm |
| | AF-2417GM103 | Ø2.4 x 1700mm | | AF-2417GM105 | Ø2.4 x 1700mm |
| | AF-2215GM103 | Ø2.2 x 1500mm | | AF-2215GM105 | Ø2.2 x 1500mm |
| | AF-2421GM103 | Ø2.4 x 2100mm | | AF-2421GM105 | Ø2.4 x 2100mm |
| | AF-2423GM103 | Ø2.4 x 2300mm | | AF-2423GM105 | Ø2.4 x 2300mm |
| | AF-2221GM103 | Ø2.2 x 2100mm | | AF-2221GM105 | Ø2.2 x 2100mm |
| | AF-1810GM103 | Ø1.8 x 1000mm | | AF-1810GM105 | Ø1.8 x 1000mm |
| | AF-1825GM103 | Ø1.8 x 2500mm | | AF-1810GM105 | Ø1.8 x 1000mm |

| | | | | | |
|--|------------|---------------|--|---------------|---------------|
|  <p>Basket type</p> | AF-1815GL2 | Ø1.8 x 1500mm |  <p>Rubber tips type</p> | AF-1815GM102 | Ø1.8 x 1500mm |
| | AF-2415GL2 | Ø2.4 x 1500mm | | AF-2415GM102 | Ø2.4 x 1500mm |
| | AF-2417GL2 | Ø2.4 x 1700mm | | AF-2417GM102 | Ø2.4 x 1700mm |
| | AF-2421GL2 | Ø2.4 x 2100mm | | AF-2215GM102 | Ø2.2 x 1500mm |
| | AF-2423GL2 | Ø2.4 x 2300mm | | AF-2421GM102 | Ø2.4 x 2100mm |
| | AF-1810GL2 | Ø1.8 x 1000mm | | AF-2423GM102 | Ø2.4 x 2300mm |
| | AF-1807GL2 | Ø1.8 x 700mm | | AF-2221GM102 | Ø2.2 x 2100mm |
| | | | AF-1810GM102 | Ø1.8 x 1000mm | |

| | | | | | |
|---|------------|---------------|--|------------|---------------|
|  <p>Rat tooth with alligator</p> | AF-1815GJ1 | Ø1.8 x 1500mm |  <p>Rat tooth type</p> | AF-1815GI1 | Ø1.8 x 1500mm |
| | AF-2415GJ1 | Ø2.4 x 1500mm | | AF-2415GI1 | Ø2.4 x 1500mm |
| | AF-2417GJ1 | Ø2.4 x 1700mm | | AF-2417GI1 | Ø2.4 x 1700mm |
| | AF-2215GJ1 | Ø2.2 x 1500mm | | AF-2215GI1 | Ø2.2 x 1500mm |
| | AF-2421GJ1 | Ø2.4 x 2100mm | | AF-2421GI1 | Ø2.4 x 2100mm |
| | AF-2423GJ1 | Ø2.4 x 2300mm | | AF-2423GI1 | Ø2.4 x 2300mm |
| | AF-2221GJ1 | Ø2.2 x 2100mm | | AF-2221GI1 | Ø2.2 x 2100mm |
| | AF-1810GJ1 | Ø1.8 x 1000mm | | AF-1810GI1 | Ø1.8 x 1000mm |
| | AF-1825GJ1 | Ø1.8 x 2500mm | | AF-1825GI1 | Ø1.8 x 2500mm |

| | | | | | |
|--|------------|---------------|---|------------|---------------|
|  <p>Pelican jaws type</p> | AF-1815GK1 | Ø1.8 x 1500mm |  <p>Alligator jaws type</p> | AF-1815GH1 | Ø1.8 x 1500mm |
| | AF-2415GK1 | Ø2.4 x 1500mm | | AF-2415GH1 | Ø2.4 x 1500mm |
| | AF-2417GK1 | Ø2.4 x 1700mm | | AF-2417GH1 | Ø2.4 x 1700mm |
| | AF-2215GK1 | Ø2.2 x 1500mm | | AF-2215GH1 | Ø2.2 x 1500mm |
| | AF-2421GK1 | Ø2.4 x 2100mm | | AF-2421GH1 | Ø2.4 x 2100mm |
| | AF-2423GK1 | Ø2.4 x 2300mm | | AF-2423GH1 | Ø2.4 x 2300mm |
| | AF-2221GK1 | Ø2.2 x 2100mm | | AF-2221GH1 | Ø2.2 x 2100mm |
| | AF-1810GK1 | Ø1.8 x 1000mm | | AF-1810GH1 | Ø1.8 x 1000mm |
| | AF-1825GK1 | Ø1.8 x 2500mm | | | |

Scissors Type (Autoclave)

■ Gastroscope
 ■ Colostomy
 ■ Bronchoscope
 ■ Enteroscope
 ■ Choledochoscope

| | | | | | |
|--|---------------|---------------|---|--------------|---------------|
|  <p>Surgical scissors</p> | AF-1815GO101 | Ø1.8 x 1500mm |  <p>N-scissors (ligation line scissors)</p> | AF-1815GO102 | Ø1.8 x 1500mm |
| | AF-2415GO101 | Ø2.4 x 1500mm | | AF-2415GO102 | Ø2.4 x 1500mm |
| | AF-2417GO101 | Ø2.4 x 1700mm | | AF-2417GO102 | Ø2.4 x 1700mm |
| | AF-2215GO101 | Ø2.2 x 1500mm | | AF-2215GO102 | Ø2.2 x 1500mm |
| | AF-2421GO101 | Ø2.4 x 2100mm | | AF-2421GO102 | Ø2.4 x 2100mm |
| | AF-2423GO101 | Ø2.4 x 2300mm | | AF-2423GO102 | Ø2.4 x 2300mm |
| AF-2221GO101 | Ø2.2 x 2100mm | AF-2221GO102 | Ø2.2 x 2100mm | | |

Accessories for HF Current Devices (Autoclave)

■ Gastroscope
 ■ Coloscope
 ■ Bronchoscope
 ■ Enteroscope
 ■ Choledochoscope

| Type | Model | Spec |
|--|------------|---------------|
|  | AF-1815DQ6 | Ø1.8 x 1500mm |
| | AF-2415DQ6 | Ø2.4 x 1500mm |
| | AF-2417DQ6 | Ø2.4 x 1700mm |
| | AF-2421DQ6 | Ø2.4 x 2100mm |
| | AF-2423DQ6 | Ø2.4 x 2300mm |
| | AF-1810DQ6 | Ø1.8 x 1000mm |
| | AF-1825DQ6 | Ø1.8 x 2500mm |

Ball type coagulation Electrodes

Remarks: 1 Package: 1 PC main body, 4 round tips & 4 extra long tips

| Type | Model | Spec |
|--|------------|---------------|
|  | AF-2415DG2 | Ø2.4 x 1500mm |
| | AF-2417DG2 | Ø2.4 x 1700mm |
| | AF-2421DG2 | Ø2.4 x 2100mm |
| | AF-2423DG2 | Ø2.4 x 2300mm |
| | | |

Hot biopsy forcep

Remarks: 1 Package: 1 PC WSD handle, 1 PC Instrument

| | | |
|--|------------|---------------|
|  | AF-2415DZ2 | Ø2.4 x 1500mm |
| | AF-2417DZ2 | Ø2.4 x 1700mm |
| | AF-2421DZ2 | Ø2.4 x 2100mm |
| | AF-2423DZ2 | Ø2.4 x 2300mm |

Easting knife in the shape of metal

| | | |
|--|------------|---------------|
|  | AF-1815DL2 | Ø1.8 x 1500mm |
| | AF-2415DL2 | Ø2.4 x 1500mm |
| | AF-2417DL2 | Ø2.4 x 1700mm |
| | AF-2421DL2 | Ø2.4 x 2100mm |
| | AF-2423DL2 | Ø2.4 x 2300mm |
| | AF-1810DL2 | Ø1.8 x 1000mm |
| | AF-1825DL2 | Ø1.8 x 2500mm |

Herangular type snare

Remarks: 1 Package: 1 PC WSD handle, 2 PC Snares.
We have different extended size: 15mm, 25mm, 32mm

| | | |
|--|------------|---------------|
|  | AF-1815DB2 | Ø1.8 x 1500mm |
| | AF-2415DB2 | Ø2.4 x 1500mm |
| | AF-2417DB2 | Ø2.4 x 1700mm |
| | AF-2421DB2 | Ø2.4 x 2100mm |
| | AF-2423DB2 | Ø2.4 x 2300mm |
| | AF-1810DB2 | Ø1.8 x 1000mm |
| | AF-1825DB2 | Ø1.8 x 2500mm |

Half-moon type snare

Remarks: 1 Package: 1 PC WSD handle, 2 PC Snares.
We have different extended size: 15mm, 25mm, 32mm

| | | |
|--|------------|---------------|
|  | AF-1815DT2 | Ø1.8 x 1500mm |
| | AF-2415DT2 | Ø2.4 x 1500mm |
| | AF-2417DT2 | Ø2.4 x 1700mm |
| | AF-2421DT2 | Ø2.4 x 2100mm |
| | AF-2423DT2 | Ø2.4 x 2300mm |
| | AF-1810DT2 | Ø1.8 x 1000mm |
| | AF-1825DT2 | Ø1.8 x 2500mm |

Standard oval type snare

Remarks: 1 Package: 1 PC WSD handle, 2 PC Snares.
We have different extended size: 15mm, 25mm, 32mm

Brushes

■ Gastroscope
 ■ Coloscope
 ■ Bronchoscope
 ■ Enteroscope
 ■ Choledochoscope

| | | |
|--|--------------|---------------|
|  | AF-1816WA302 | Ø1.8 x 1600mm |
| | AF-2416WA302 | Ø2.4 x 1600mm |
| | AF-2422WA302 | Ø2.4 x 2200mm |
| | AF-1810WA302 | Ø1.8 x 1000mm |

Cytology brush

| | | |
|--|--------------|---------------|
|  | AF-2416WA301 | Ø2.4 x 1600mm |
| | AF-2422WA301 | Ø2.4 x 2200mm |
| | AF-1810WA301 | Ø1.8 x 1000mm |

Channel cleaning brush

| | |
|--|--------------|
|  | AF-1004WA303 |
|--|--------------|

Brush aqueous button cleaning

Stomach stones cutter and Lithotriaptor

Stomach stones cutting expert, Efficient lithotripsy tool

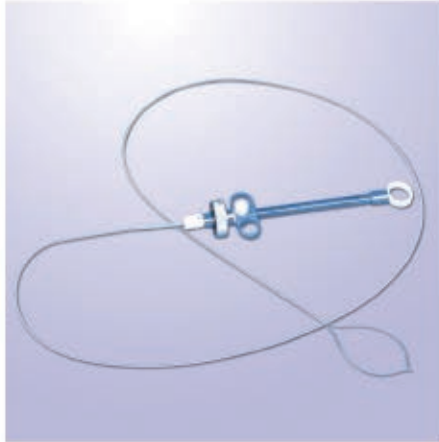
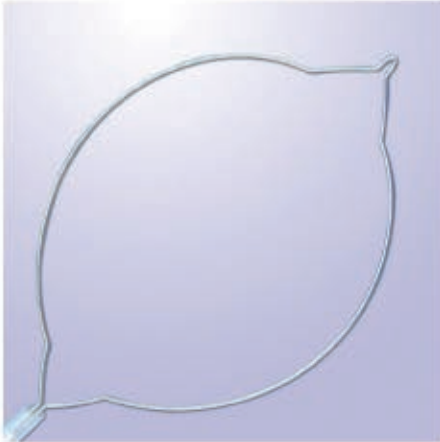

Standard set includes:
 One Lithotriaptor handle,
 a set of Sheath, five
 pieces of inner core
 Model:AF-2417DT4
 AF-2423DT4
 Channel Dia.: $\geq 2.8\text{mm}$



Handle of the cutter

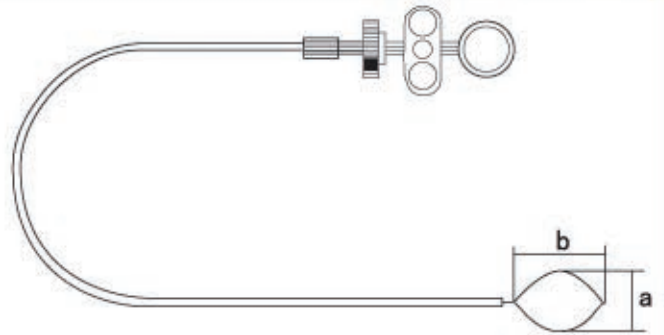

Remarks:

AF-2423DT4 extended size (acm * bcm) extended size(5cm * 6cm) -- (10cm *13cm)



ESSE 3 Via Garibaldi 30
 14022Castelnuovo D.B. (AT)
 tel +39 011 99 27 706
 fax +39 011 99 27 506
 e-mail esse3@chierinet.it
 web : www.4ci.com

